

9U 550 X 450 MM



CLASSIC MODEL

FEATURES

- ◆ Exquisite Design with Precise dimension
- ◆ Static Loading 60kgs | Easy & Quick wall mounting
- ◆ Cable entry Top & Bottom | Numbered U positions
- ◆ Turing angle of front door over 180°
- ◆ Powder coated with Ten tank pretreatment process meeting ASTM std. Frame RAL 7035 & door RAL 7037
- ◆ HiTech Manufacturing | Quality Management System
- ◆ DIN 41494/Equivalent 19" International Standards
- ◆ Front toughened glass door with lock & key
- ◆ Material SPCC Quality Cold Rolled Sheet

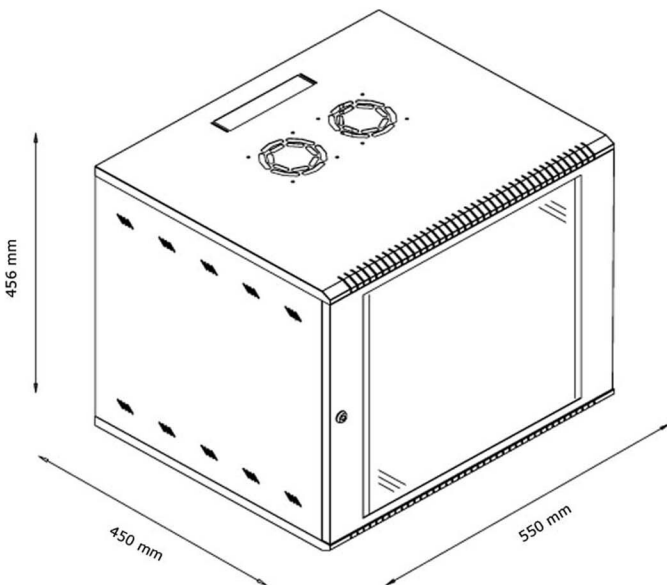

SPECIFICATION

Model No	MWM CLS 045 09
Capacity	9U
Width	550 mm
Depth	450 mm
Height	456 mm
Usable Depth	370 mm
Usable Height	416 mm
Mounting Width	518 mm
Mounting Height	360 mm