

18U 600 X 800 MM



STANDARD MODEL



FEATURES

- ◆ Exquisite Design with Precise dimension
- ◆ Static Loading 800kgs | Adjustable Heavy duty Castors
- ◆ Removable Side Panels | Cable entry Top & Bottom
- ◆ Turing angle of front and rear door over 180°
- ◆ Powder coated with Ten tank pretreatment process meeting ASTM std all RAL 9005 | Numbered U positions
- ◆ HiTech Manufacturing|Quality Management System
- ◆ DIN 41494/Equivalent 19" International Standards
- ◆ Front Toughened Glass Door with lock & key
- ◆ Material SPCC Quality Cold Rolled Sheet

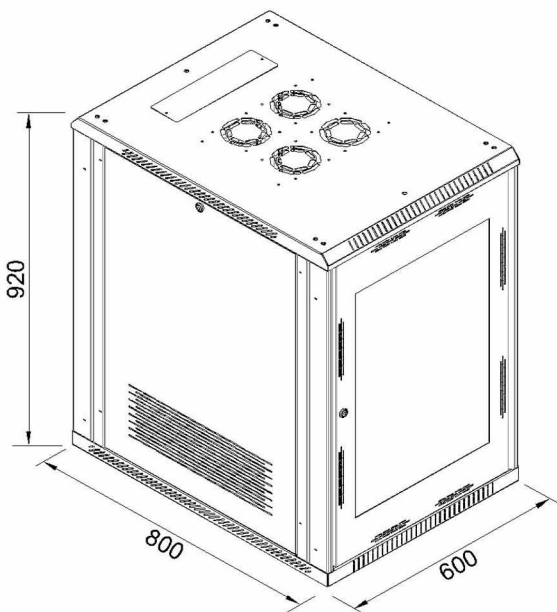

SPECIFICATION

Model No	MFS STD 080 18
Capacity	18U
Width	600 mm
Depth	800 mm
Height	920 mm
Usable Depth	650 mm
Usable Height	816 mm
Castor Height	100 mm
Total Height	1020 mm