

**6U 550 X 600 MM**



**JUMBO MODEL**

**FEATURES**

- ◆ Max Loading 60kgs
- ◆ Convenient and quick wall mounting
- ◆ Cable entry on Top & Bottom cover
- ◆ Turing angle of front door over 180°
- ◆ Powder coating frame RAL 7035 door RAL 7016
- ◆ 19" standard installation
- ◆ Welded Frame, Reliable structure
- ◆ Front Toughened Glass Door with lock & key
- ◆ Material SPCC Quality Cold Rolled Sheet
- ◆ HiTech Manufacturing|Quality Management System

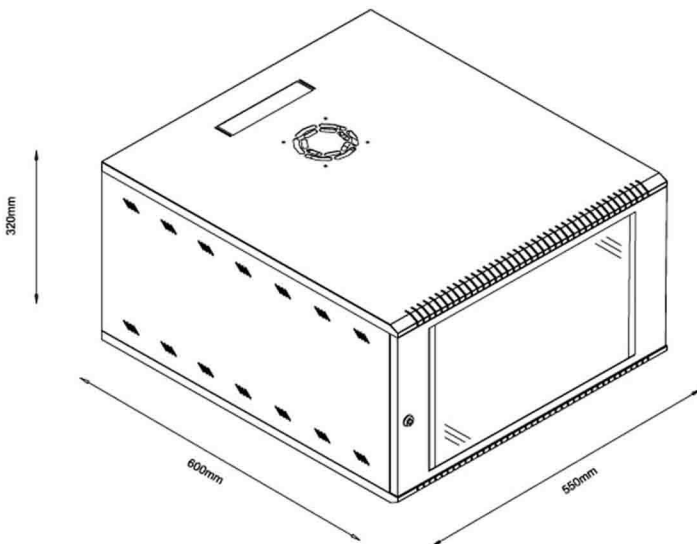

**SPECIFICATION**

Model No	MWM JUM 040 06
Capacity	6U
Width	550 mm
Depth	600 mm
Height	320 mm
Usable Depth	495 mm
Usable Height	281 mm
Mounting Width	518 mm
Mounting Height	227 mm