

15U 550 X 450 MM



CLASSIC MODEL



FEATURES

- ◆ Max Loading 60kgs
- ◆ Convenient and quick wall mounting
- ◆ Cable entry on Top & Bottom cover
- ◆ Turing angle of front door over 180°
- ◆ Powder coating frame RAL 7035 door RAL 7016
- ◆ 19" standard installation
- ◆ Welded Frame, Reliable structure
- ◆ Front Toughened Glass Door with lock & key
- ◆ Material SPCC Quality Cold Rolled Sheet
- ◆ HiTech Manufacturing|Quality Management System

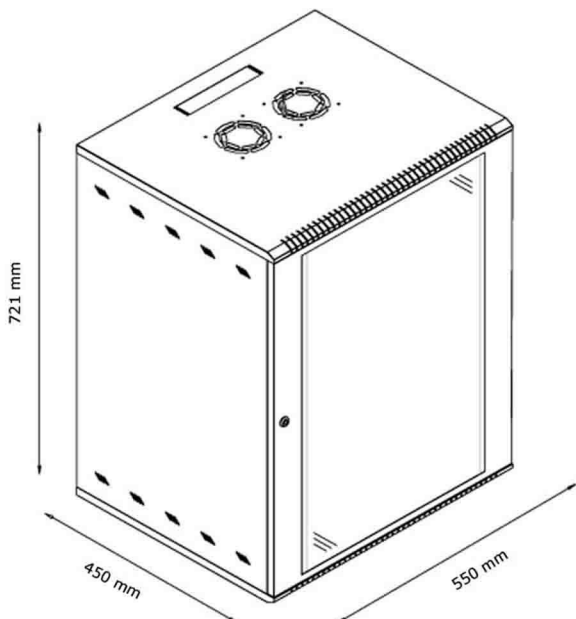

SPECIFICATION

Model No	MWM CLS 045 15
Capacity	15U
Width	550 mm
Depth	450 mm
Height	721 mm
Usable Depth	370 mm
Usable Height	681 mm
Mounting Width	518 mm
Mounting Height	625 mm