

22U 600 X 600 MM



STANDARD MODEL



FEATURES

- ◆ Exquisite Design with Precise dimension
- ◆ Static Loading 600 kgs
- ◆ Cable entry on Top & Bottom cover
- ◆ Turing angle of front and rear door over 180°
- ◆ Powder coating frame RAL 7035 door RAL 7016

- ◆ Reliable Structure with high Craftmanship
- ◆ Compatible with 19" International Standards
- ◆ Front Toughened Glass Door with lock & key
- ◆ Material SPCC Quality Cold Rolled Sheet
- ◆ HiTech Manufacturing|Quality Management System

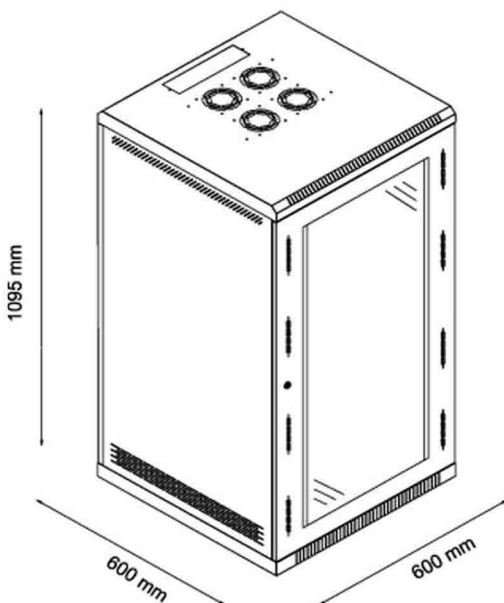

SPECIFICATION

Model No	MFN STD 060 22
Capacity	22U
Width	600 mm
Depth	600 mm
Height	1095 mm
Usable Depth	500 mm
Usable Height	995 mm
Castor Height	75 mm
Total Height	1170 mm